

SPECIFICATION

High Quality Switching Power Adapter

**Universal AC Input
24W 12V 2.0A
Single Output**

P/N: A120020ENI

**** Specification Approval****

This specification (total 7 pages including cover page) is approved in it's entirety by:

Company Name

Print Name

Signature

Date



Santa Clara CA 95054
Tel: 1-408-980-9813
Fax: 1-408-980-8626
Email: infor@topmicro.com
Web: www.topmicro.com
111309RBV.A

1. General

1.1 Scope

A120020ENI is a universal switching power adapter operating at input voltage 90-264VAC with single 12V 2.0A output. This specification defines it's electrical, mechanical and environmental parameters.

1.2 Electric Characteristics

1.2.1 Input

No	ITEM	SPECIFICATION
1.	Rated Input Voltage	AC100-240V
	Vibration Input Voltage Range	AC90-264V
2.	Frequency Rated	50-60Hz
	Frequency Vibration	47-63Hz
3.	Input Rated Current	0.8A RMS Max
	Inrush Current	50A Max. at 115VAC cold-start
		100A Max. at 230VAC cold-start
4.	Leakage Current	<0.25mA
5.	Efficiency	82.1% Min (CEC V)
6	No Load Consumption	<0.3W Max (CEC V)

1.2.2 Output:

No	ITEM	SPECIFICATION
1.	Output Voltage	12VDC±5%
2.	Output max. Current	2.0A
3.	Output min. Current	0A
4.	Line Regulation	±1%
5.	Short Circuit Protection	Output shut down and auto restart
6.	Over Temperature Protection	There shall be no ignition or smoke and deformation of case
7.	Ripple Voltage	200mV (p-p) (100-240V AC Input)

Measuring is done by 20MHz bandwidth oscilloscope and terminated each output with a 10uf aluminum electrolytic capacitor and 0.1uf ceramic capacitor.

1.2.3 Hi-Pot Specification

Input to output: 1500VAC 10mA 1 minute.

1.2.4 Insulation Resistance:

Input to output: 500VDC to test the input to output resistance not be less 100M ohm

1.2.6 EMI Standard: Meet FCC Class B,VCCI

1.2.7 PB-free Standard: RoHS Compliant

1.3 Mechanical Characteristics

1.3.1 AC Plug : IEC320 /C8 inlet

1.3.2 DC cord:

Bending test: Life 1000 times 100% guarantee. Swings 120 from

Left to right loading weight 200g, 40 cycle/minute.

Pull test: DC cord and plug, weight 6kg for 1 minute.

1.3.3 Weight: 139g

1.3.4 Case Size: (L)80 .6X (W)50X (H)31mm

1.3.5 Ambient Operating Temperature

Operating: 0°C to 40°C

Storage: -10°C to 70°C

1.3.6 Humidity

Operating: 20% to 80%

Storage: 10% to 90%

2.0 Drawing

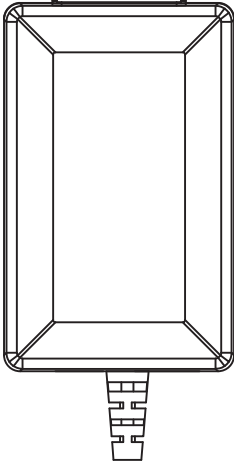
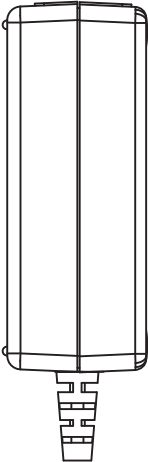
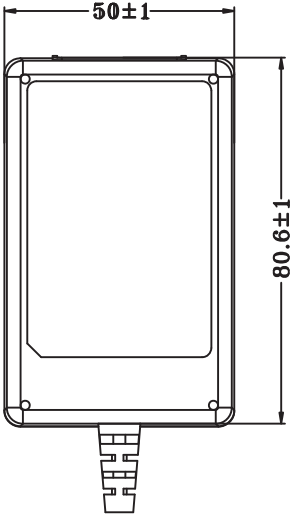
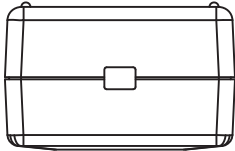
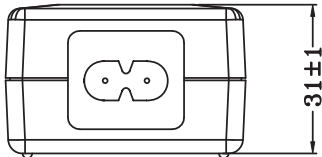

3.0 DC Plug

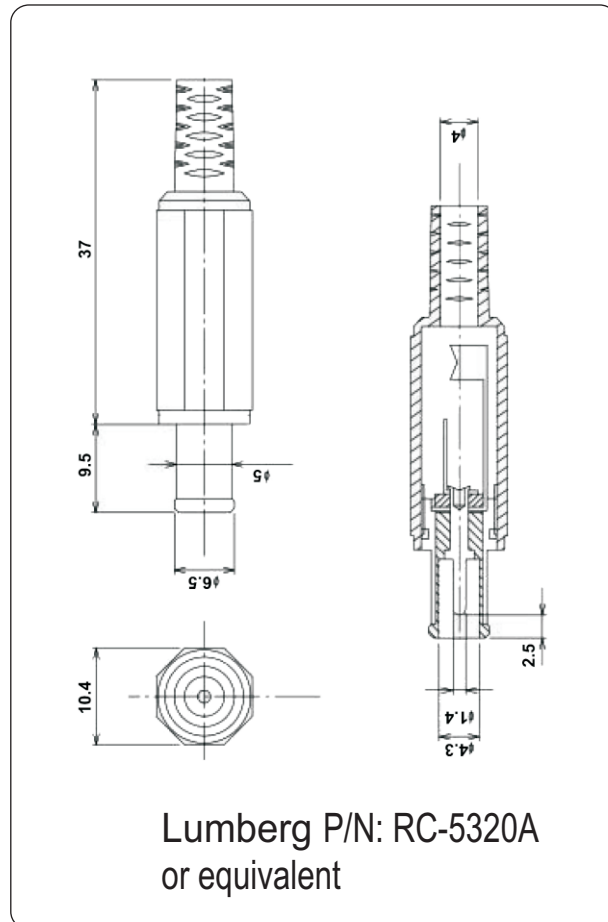
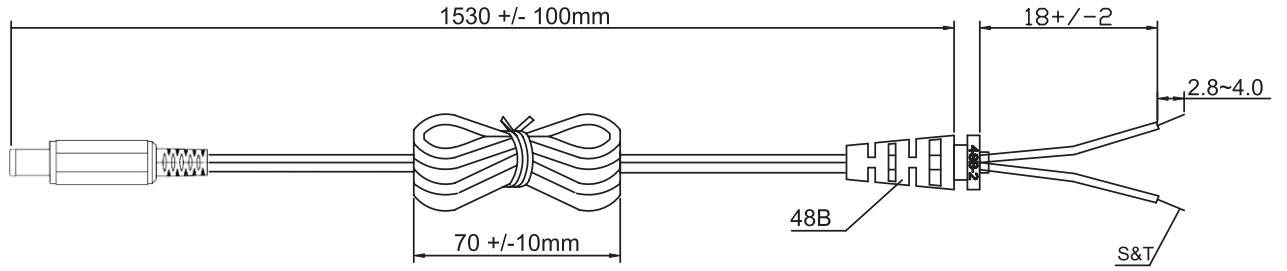

4.0 Rating Label

