

SPECIFICATION

High Quality Switching Desktop Adapter

**Universal AC Input
10W 5.0VDC Output**

P/N:A050040EN1

****Specification Approval****

This specification (total 7 pages including cover page) is approved in it's entirety by:

Company Name	Print Name	Signature	Date
--------------	------------	-----------	------



Santa Clara CA 95054
Tel: 1-408-980-9813
Fax: 1-408-980-8626
Email: infor@topmicro.com
Web: www.topmicro.com
111110V1.0

1. General

Top Microsystems model A050040EN1 zzzz is a universal switching-mode power supply, operating at input voltage 90 to 264VAC and providing output voltage of 5VDC 4.0A Max.

2. Electric

2.1 Input

No	ITEM	SPECIFICATION
1.	Rated input Voltage	AC100V-240V
	Vibration input Voltage Range	AC90V-264V
2.	Frequency Rated	50-60Hz
	Frequency Vibration	47-63Hz
3.	Input Rated Current	500mA RMS Max
	Inrush Current	40A Max. at 115vac cool start
		80A Max. at 230vac cool start
4.	Leakage current	0.75mA
5.	Efficiency	78.57% Min CEC Compliant
6.	Standby Power(NO Load)	<0.3W CEC Compliant

2.2 Output

No	ITEM	SPECIFICATION	
1.	Output Voltage	5VDC	
2.	Output Max. Current	4.0A	
3.	Output Min. Current	0A	
4.	Line and Load Regulation	$\pm 5\%$	
6.	Over Voltage Protection	The output voltage shall be clamped by internal protection zener	
7.	Short Circuit Protection	Output shut down and auto restart	
8.	Ripple Voltage (L.F.)	150mV(P-P)	INPUT:100V~240V AC OUTPUT: FULL LOAD

2.3 Hi-Pot Specification:

Input to Output: 1500VAC or 2121VDC 10mA 1 minute.

2.4 Insulation Resistance:

Input to Output: 500vdc to test the input to output resistance not be less 100M ohm

2.5 Regulatory Approval:

UL/cUL, GS, PSE, CE, FCC, PSE

2.6 EMI standard:

meet FCC class B, EN55022 Class B

2.7 Environmental compliance:

RoHS Compliant

3. Mechanical

3.1 AC Plug:

Inlet IEC320/C14, 3Pin Type

3.2 DC Cord Bend Test:

Bending test: Life 1000 times 100% guarantee. Swings 120 from left to right loading weight 200g , 40 cycle/minute.

3.3 DC Cord Pull Test:

Pull test: DC cord and plug, weight 6kg for 1 minute.

3.4 Case Size:

(L)80.6 x (W)50 x (H)31mm

3.5 Temperature

Operating: 0°C to +40°C

Storage : -10°C to +70°C

3.6 Humidity

Operating: 20% to 80%.

Storage: 10% to 90%

4. DC Cable and Plug

Unit: mm

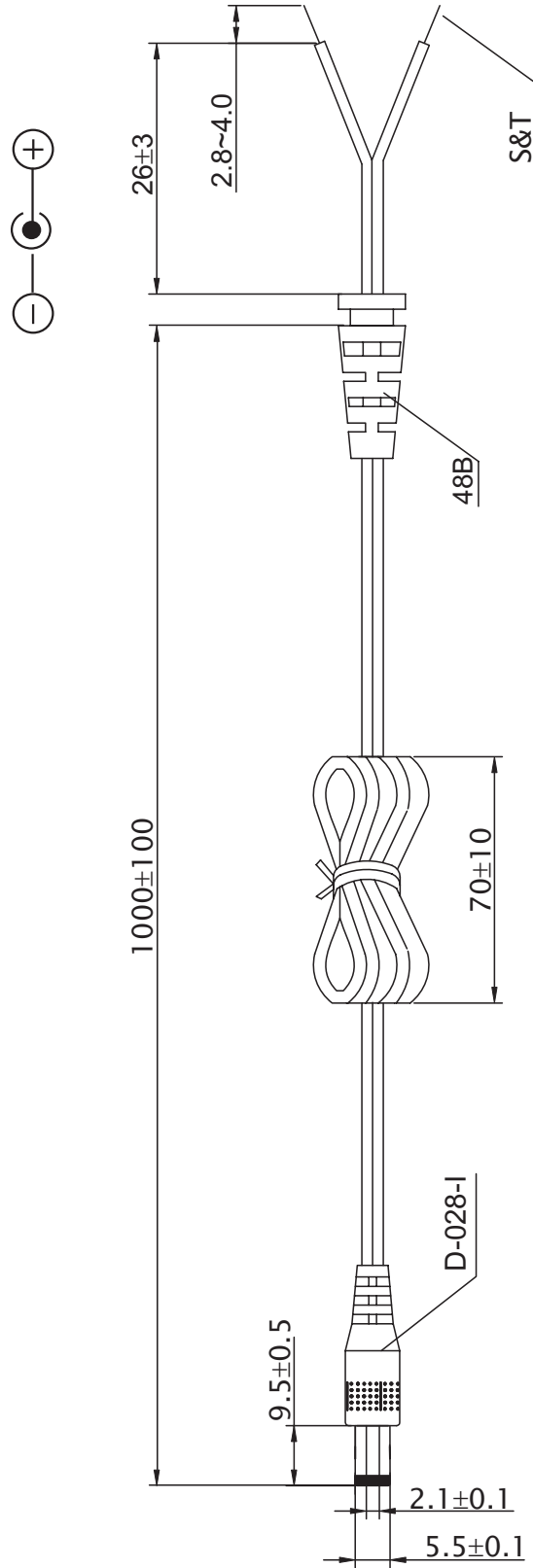







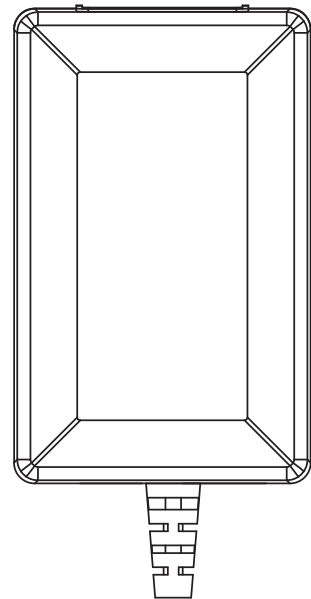
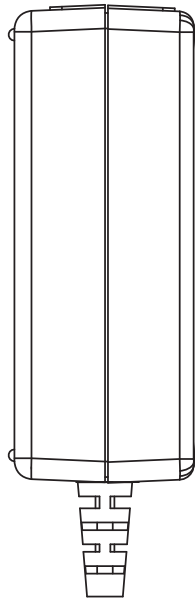
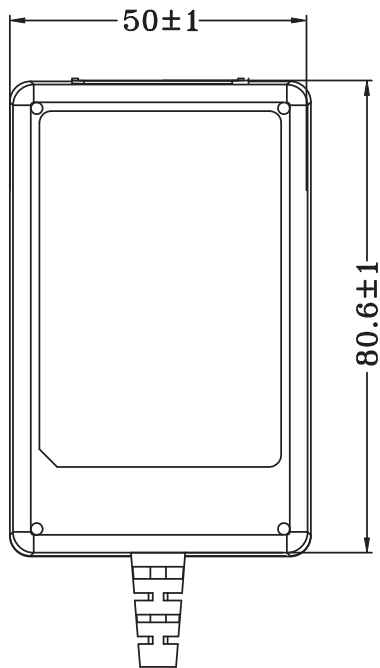
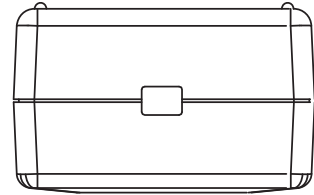
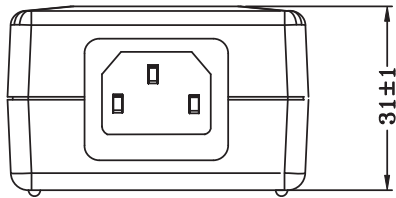



- A. Cord Material: 2468 18#*2C (UL approval)
- B. DC Plug Type: ID2.1*OD5.5*L9.5mm
- C. Body and Out Jacket PVC Color: Black
- D. Output Cable Jacket Temperature: 80°C Max
- E. RoHS Compliance: Body and all components including DC cable and plug.

5. Mechanical Drawing

Unit: mm



6. Label

		Switching Adapter	
P/N: A050040EN1			
Input: 100-240V ~ 50-60Hz 0.5A			
Output: 5V --- 4.0A 			
	入力: AC100V ~ 50-60Hz 0.5A 出力: DC5V --- 4.0A		
			
LISTED E176899	LPS	RoHS	
CAUTION: For I.T.E Use Only. Risk of Shock. Do Not Open.			
	WWW.TOPMICRO.COM		
L/N: TEN-YYWW	Made in China		

YY: Year, WW: Week